

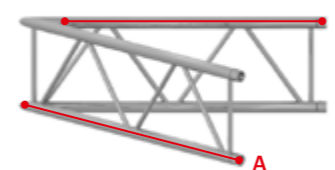

Photo: Riegler Messebau, Italy. Project: Introduction new Porsche.

Ladder Corners

| measurements in mm | A | B | C | D | E | F | G | H | J | K | L | M | N | P |
|--------------------|------|------|------|-----|-----|-----|-----|------|-----|-----|-----|-----|-----|-----|
| X30L | 1000 | 877 | 913 | 500 | 449 | 471 | 479 | 949 | 300 | 498 | 210 | 333 | 380 | 710 |
| H40L | 1200 | 1078 | 1112 | 600 | 549 | 572 | 579 | 1149 | 258 | 525 | 210 | 376 | 439 | 810 |

C001U - 45°



C002U - 60°

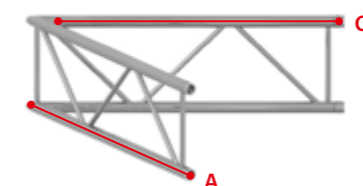

C003U - 90°

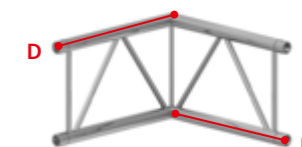

C004U - 120°

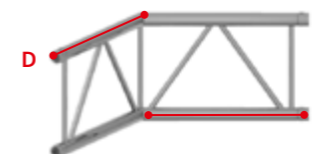

C005U - 135°

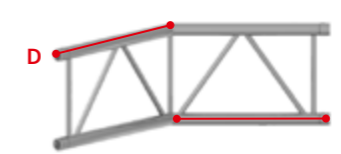

C016U

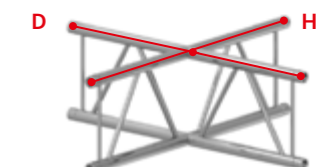

C017U

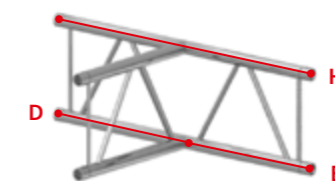

C001F - 45°

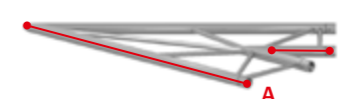

C002F - 60°

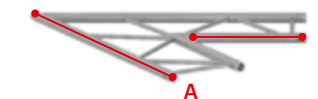

C003F - 90°

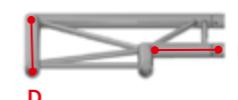

C004F - 120°



C005F - 135°

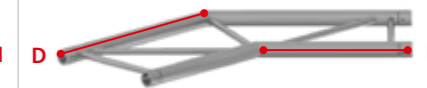

C016F



C017F

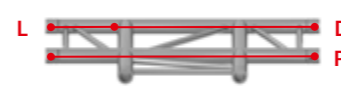

U = LADDER UP
F = LADDER FLAT

20 SERIES



30/40 SERIES



36R/36V



S52F



S100F





Triangular Corners

| measurements in mm | A | B | C | D | E | F | G | H | K | L |
|--------------------|------|-----|-----|-----|-----|-----|-----|-----|-----|-----|
| E20D | 800 | 264 | 415 | 400 | 178 | 272 | 308 | 203 | 578 | 603 |
| X/H30D | 1000 | 300 | 498 | 500 | 210 | 333 | 380 | 242 | 710 | 742 |
| H40D | 1200 | 258 | 525 | 600 | 210 | 376 | 439 | 255 | 810 | 855 |

Triangular Corners

| measurements in mm | A | B | C | D | E | F | G | H | K | L |
|--------------------|------|-----|-----|-----|-----|-----|-----|-----|-----|-----|
| E20D | 800 | 264 | 415 | 400 | 178 | 272 | 308 | 203 | 578 | 603 |
| X/H30D | 1000 | 300 | 498 | 500 | 210 | 333 | 380 | 242 | 710 | 742 |
| H40D | 1200 | 258 | 525 | 600 | 210 | 376 | 439 | 255 | 810 | 855 |

C001 - 45°

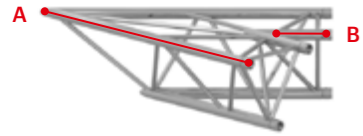

C002 - 60°

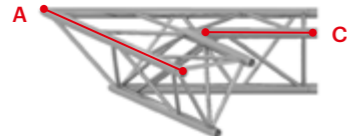

C003 - 90°

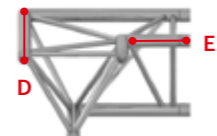

C004 - 120°

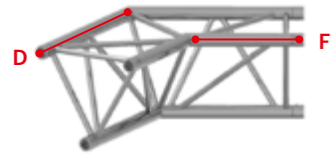

C005 - 135°

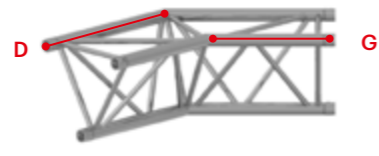

C006

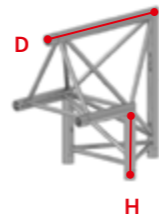

C007

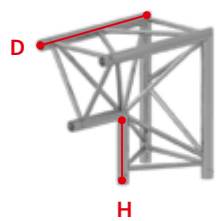

C010

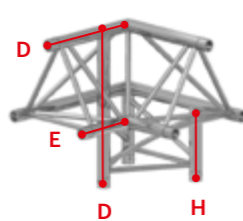

C011

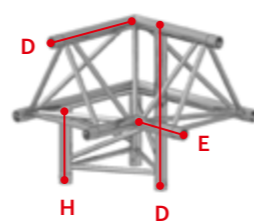

C012

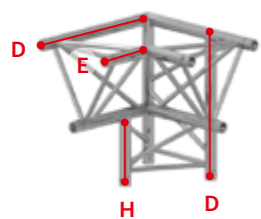

C013

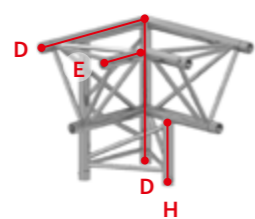

C014

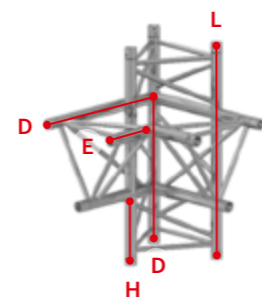

C015

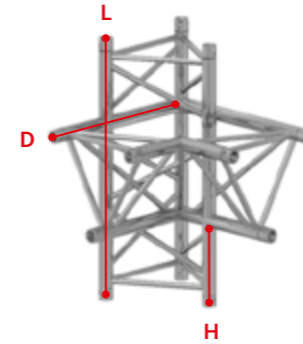

C016

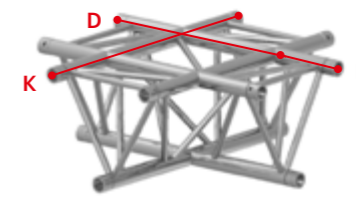

C017

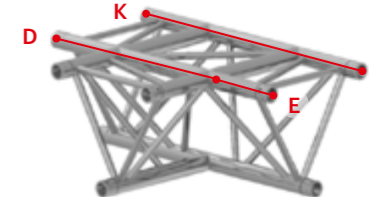

C018

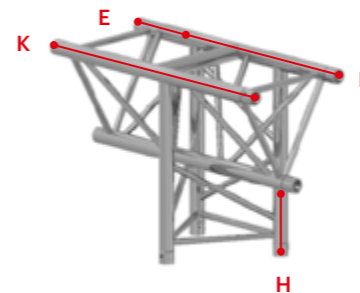

C019

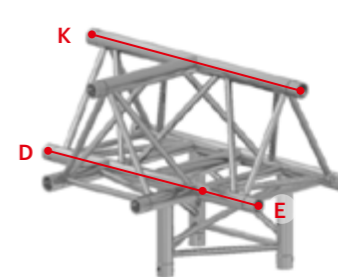

C020

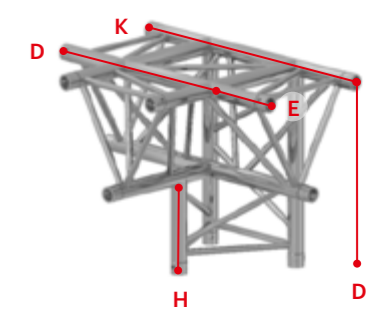

C021

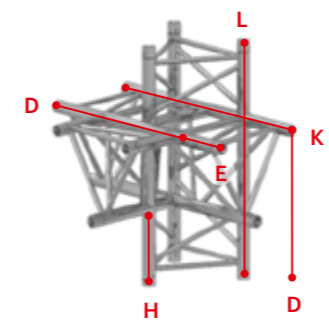

C022

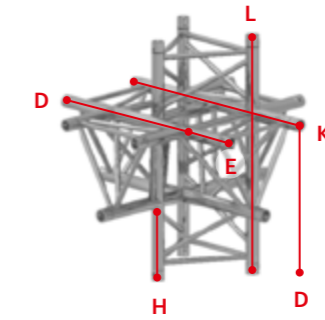

C023

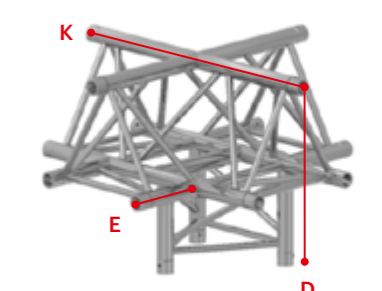

C024

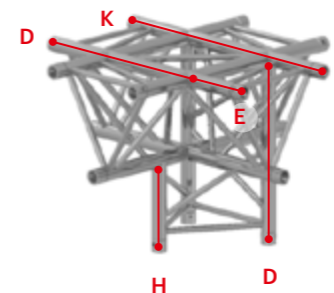

C039

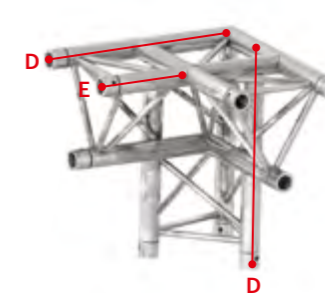



Square Corners

| measurements in mm | A | B | C | D | E | F | G | H |
|--------------------|------|-----|-----|-----|-----|-----|-----|-----|
| E20V | 800 | 264 | 415 | 400 | 178 | 272 | 308 | 578 |
| X/H30V | 1000 | 300 | 498 | 500 | 210 | 333 | 380 | 710 |
| H40V | 1200 | 258 | 525 | 600 | 210 | 376 | 439 | 810 |

Standard Corners - S36 Series

| measurements in mm | A | B | C | D | E |
|--------------------|-----|-----|-----|-----|-----|
| S36R | 475 | 125 | 600 | 429 | 172 |
| S36V | 475 | 125 | 600 | 475 | 125 |

C001 - 45°

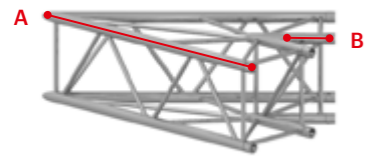

C002 - 60°

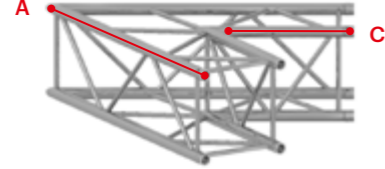

C003 - 90°

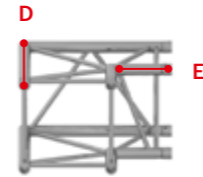

S36R - C003



S36R - C007

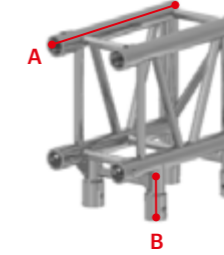

S36R - C012

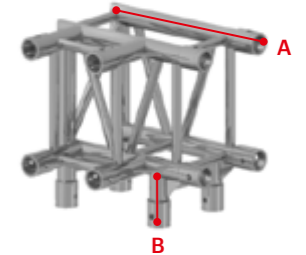

C004 - 120°

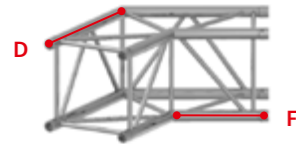

C005 - 135°

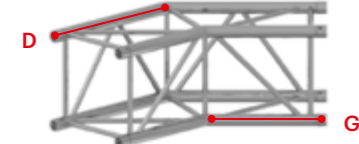

C012

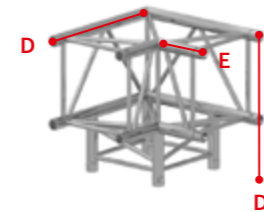

S36R - C013

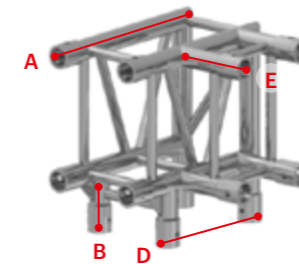

S36R - C016

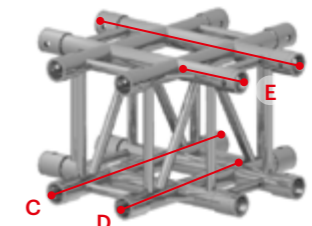

S36R - C017

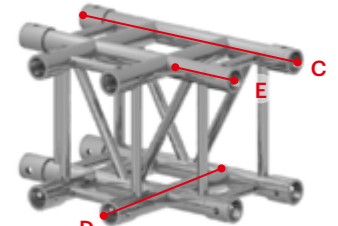

C016

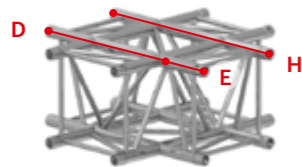

C017



C020

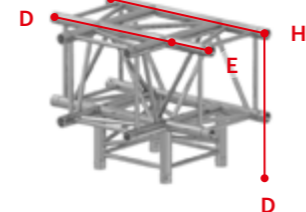

S36V - C003

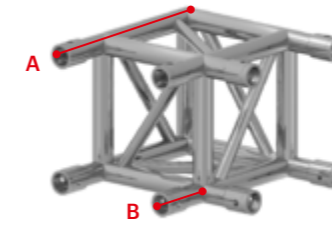

S36V - C012

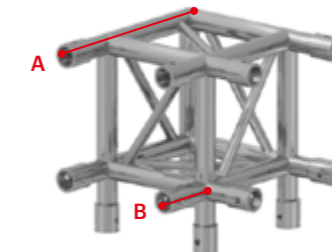

C022

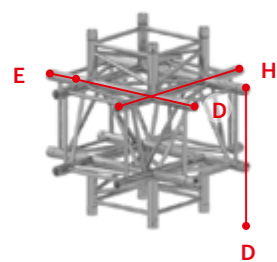

C024

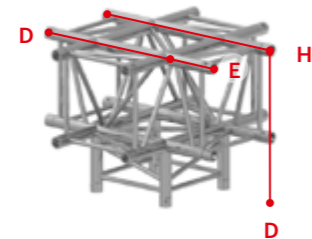



Standard Corners - S52F Series

| measurements in mm | A | B | C | D | E | F |
|--------------------|-----|-----|-----|-----|----|-----|
| S52F | 740 | 655 | 580 | 305 | 85 | 530 |

S52F - C003

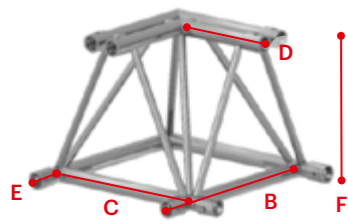

S52F - C016

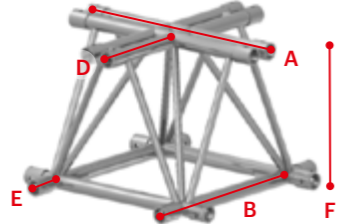

S52F - C017

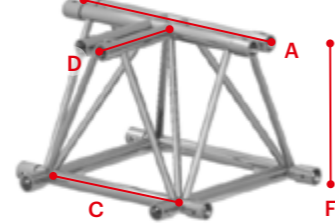

Standard Corners - S100F Series

| measurements in mm | A | B | C | D | E | F |
|--------------------|-----|-----|-----|-----|----|------|
| S100F | 740 | 655 | 570 | 305 | 85 | 1010 |

S100F - C016

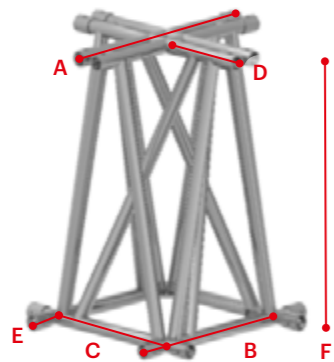

S100F - C017

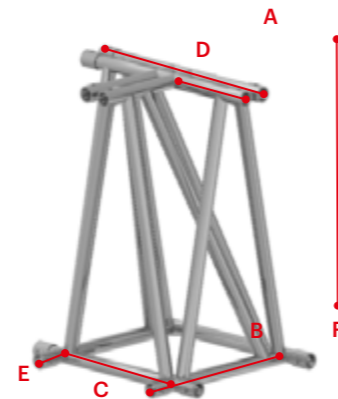

BOX-30V-0

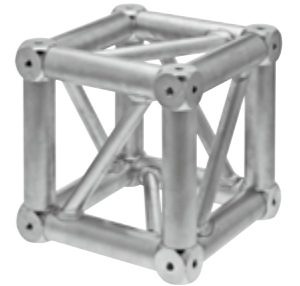
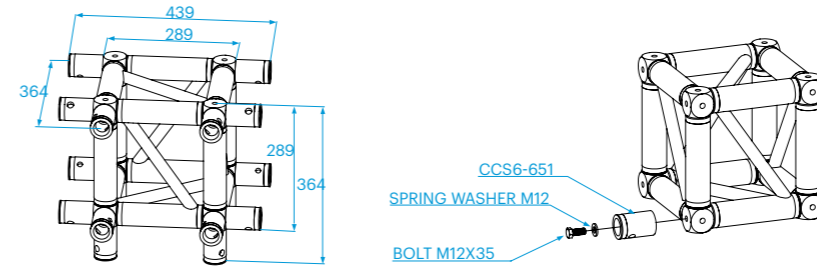

BOX-30L-0

Ladder BoxCorner for X•H30 truss. Measurements.

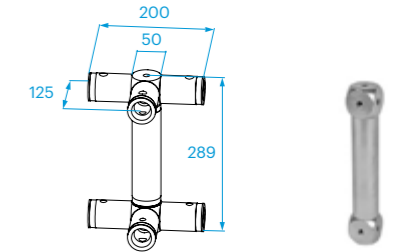
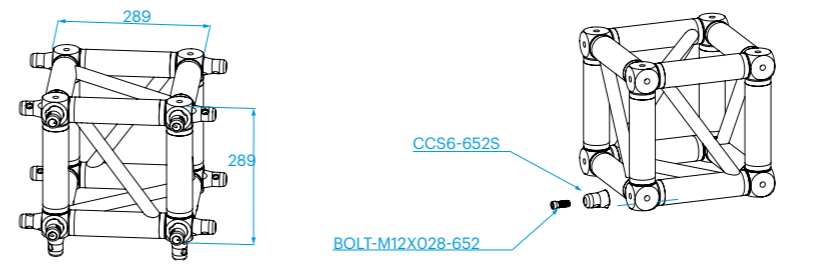

BOX-30 - KIT

Kit for fixation and assembly. CCS6-651 to box 30V.

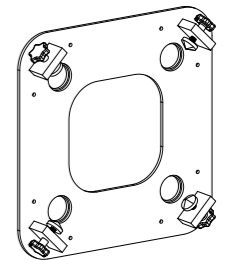
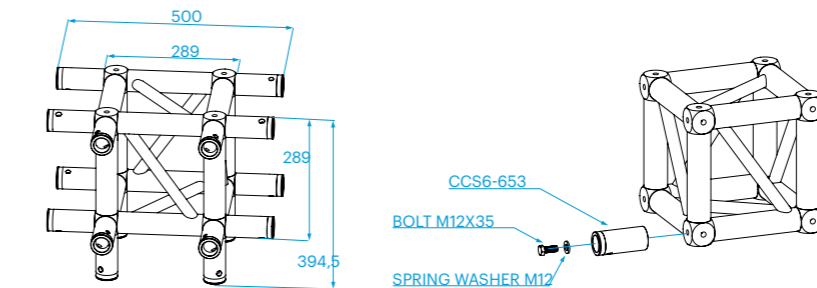

BOX-30V-A-001

BoxCorner for X • H30V truss. Measurements.

Assembly.

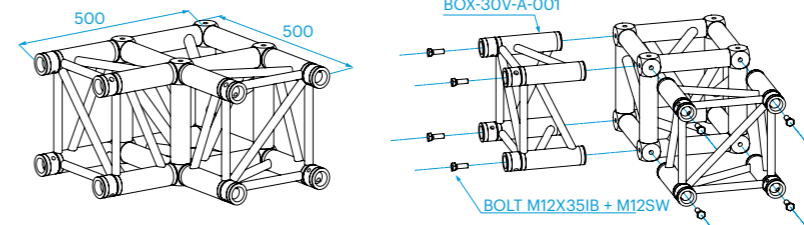

BOX-30V-ATT

BoxCorner attachment, pre- assembled CCS6-651 couplers.



BoxCorner with attachments with same dimensions as standard corner.

Technical specifications - 30V BoxCorners

| 0-way | | 2-way | | 3-way | | 4-way | | 5-way | | 6-way | | coupler | bolt | spring washer |
|-------|------|-------|------|-------|------|-------|------|-------|------|-------|------|------------|----------------|---------------|
| kg | lbs | kg | lbs | kg | lbs | kg | lbs | kg | lbs | kg | lbs | | | |
| 9,9 | 21.2 | 12,2 | 26.9 | 13,5 | 29.8 | 14,8 | 32.7 | 16,1 | 35.5 | 17,4 | 38.4 | CCS6 - 651 | BM-M12x035 | BM-M12xSW |
| | | | | | | | | | | | | CCS6 - 652 | BM12x028 - 652 | - |
| | | | | | | | | | | | | CCS6 - 653 | BM-M12x035 | BM-M12xSW |

1 inch = 25,4 mm | 1 m = 3.28 ft | 1 lbs = 0,453 kg | 1 daN = 10 N - 1 kg